



Set using ISO screws

TA-3200F



SONY[®]
SERVICE MANUAL

TABLE OF CONTENTS

<u>Section</u>	<u>Title</u>	<u>Page</u>	<u>Section</u>	<u>Title</u>	<u>Page</u>
1. TECHNICAL DESCRIPTION			4. REPACKING		15
1-1.	Technical Specifications	1	5. DIAGRAMS		
1-2.	Detailed Circuit Analysis	1~6	5-1.	Mounting Diagram	
				Power Amplifier Board	16~17
2. DISASSEMBLY AND REPLACEMENT PROCEDURES			5-2.	Mounting Diagram	
2-1.	Tools Required	7		Power Supply Board	18~19
2-2.	Hardware Identification Guide	7	5-3.	Mounting Diagram	
2-3.	Top Cover and Front Panel			Speaker Protection Board	
	Removal	7		(Up to Serial number 80,000	
2-4.	Front Subchassis Removal	8		USA Model only)	20~21
2-5.	Pilot Lamp Replacement	8	5-4.	Mounting Diagram	
2-6.	Power Transistor Replacement	9		Speaker Protection Board	
2-7.	Control and Switch			Serial number 80,801 and	
	Replacement	10		later, USA Model	
2-8.	Replacement of Components			Serial number 50,001 and	
	Secured to the Rear Panel	10~11		later, General Export	
2-9.	Chassis Layout	11		Model	22~23
3. ADJUSTMENT PROCEDURES			5-5.	Block Diagram	24
3-1.	Dc Bias Adjustment	12~13	5-6.	Schematic Diagram	25~26
3-2.	Dc Balance Adjustment	13	6. EXPLODED VIEW		27~28
3-3.	Speaker Protection Circuit		7. ELECTRICAL PARTS LIST		29~31
	Adjustment (Serial number				
	80,801 and later)	13~14			
3-4.	Caution for Maximum Output				
	Power Measurement	14			

SECTION 1

TECHNICAL DESCRIPTION

I-1. TECHNICAL SPECIFICATIONS

Technical specifications for the TA-3200F are given in Table 1.

TABLE 1. SPECIFICATIONS

Power Amplifier Section

Dynamic power output (IHF)	: 500W both channels, 4 ohms 320W both channels, 8 ohms
Rated RMS output	: 130W per channel, both channels operating, 4 ohms 110W per channel, both channels operating, 8 ohms
Power bandwidth	: 5 Hz to 35 kHz, 8 ohms (IHF)
Harmonic distortion (1 kHz)	: Less than 0.1% at rated output Less than 0.03% at 1 watt output
IM distortion (60 Hz : 7 kHz=4:1)	: Less than 0.1% at rated output Less than 0.03% at 1 watt output
Frequency response	: 5 Hz to 200 kHz at 1 watt output
Input sensitivity and impedance	: 1.4 V for rated output, 75 k ohms
Residual noise	: Less than 0.003 μ W
Signal to noise ratio	: Greater than 110 dB (shorted input)

General

Power requirement	: 110, 117, 220, or 240 V ac, 50/60 Hz
Power consumption	: 300 watts (USA, CANADA Model) 340 watts (General Export Model)
Ac outlet	: Unswitched 300 W
Dimensions	: 400 (W) X 149 (H) X 323 (D) mm 15 ³ / ₄ " (W) X 5 ⁷ / ₈ " (H) X 12 ³ / ₄ " (D)
Weight	: 14.0 kg (30 lb 10 oz)
Shipping weight	: 16.7 kg (36 lb 14 oz)

I-2. DETAILED CIRCUIT ANALYSIS

The following describes the functions of all stages and controls. The test sequence follows signal paths. Stages are listed by transistor reference designation at left margin; major components are also listed in a similar manner. Refer to the block diagram on page 24 and schematic diagram on pages 25 to 26.

<u>Stage/Control</u>	<u>Function</u>
<i>Power Amplifier Section</i>	
LEVEL Control R101	Adjusts the input signal to the level required by the power amplifier to obtain a desired output.
LOW FILTER (NORMAL/TEST) switch S2	C101 and R102 form a low-cut filter for eliminating unwanted extremely-low frequencies when the LOW FILTER switch is set to NORMAL.
FUNCTION switch	Selects either of the two signal sources connected to the input terminals.
Preamplifier Q101, Q102, Q103	Q101, Q102, and Q103 form a modified paraphase amplifier but output signal is extracted from the emitter circuit of Q103. Note that Q101 and Q102 are in a Darlington configuration. This circuit has various advantages in a direct-coupling system. One is high stability despite temperature variation and another is high input impedance without reducing the amplifier's gain. The ac output appears across load resistor R113 (R213) in the emitter circuit of Q103. An decoupling circuit formed by the emitter-base resistance of Q102, C105, and R112 is essentially a frequency-selective ac bypass to reduce the amplifier's gain at

<u>Stage/Control</u>	<u>Function</u>	<u>Stage/Control</u>	<u>Function</u>
	very low frequencies. Common emitter-resistor R106 keeps the dc current flow constant in Q101 Q102 and Q103, thus increasing the dc stability.	Thermal dc bias compensator D102, D103	The negative temperature coefficient of diodes D102 and D103 provides thermal compensation for the complementary and power transistor circuits. D102, D103 are attached to the power transistor's heat sink to detect temperature increases in the power transistors.
Dc balance adj. R141 (R241)	The stabilized positive and negative power supply voltage are picked off by R308 and R309, R310 and R311, and applied to R141. R141 provides a stabilized bias voltage for transistor Q101 to set the output terminal voltage at zero dc.	Complementary circuit Q110, Q111	These transistors operate as emitter-followers to provide the current swings demanded of the output stages and also provide the necessary phase inversion. Phase inversion is performed by using PNP and NPN type transistors.
Thermal compensation and noise suppressor D101	As all the stages are directly coupled, dc stability is required. The negative temperature coefficient of D101 provides thermal compensation for the following driver stage. It also acts as a noise suppressor to reduce the popping noise due to unbalanced current flow in the following stages when the power switch is turned off.	Power transistor Q112, Q113	The output transistors Q112 and Q113 are connected directly to a power supply of about ± 67 V. Q112 supplies power to the load during positive half cycle and Q113 operates during the negative half cycle. As all the stages are directly coupled and designed to obtain zero potential at the output terminal, the large coupling capacitor at the output which may cause power loss or distortion at low frequencies is eliminated.
Driver Q104	Though this stage is a conventional flat amplifier, it determines the output voltage, swings because the following stages are basically emitter-followers. The ac load resistor for this stage is R118.	Protection circuit	Two kinds of protection circuits are employed in this power amplifier. One is a power transistor protection circuit and the other is a speaker protection circuit.
Dc bias adj. (idling current) Q105, R117	Q105 is biased into conduction and operates as a small resistance providing the necessary forward bias on the two cascaded emitter-followers. R117 controls the base bias of Q105, determining its emitter-collector impedance and thereby controls the dc bias voltage for the following complementary circuit.	Power transistor protection circuit	To protect overloaded power transistors from destruction, a new protection circuit is employed. In the event of a short circuit at the output terminals,

the protection circuit holds down the current in the power transistor so as not to make it overheat and also limits the input drive signals. Fig. 1-1 shows a partial schematic diagram detailing the protection circuit. With reference to this diagram, the protection circuit operates as follows: (Since the protection circuit is identical for positive-going half cycles and negative-going half cycles, only the positive-going half cycle operation is described here.) Q106 and Q108 limit the positive-going half cycle of the drive voltage applied to the base of Q110 when power consumption at the Q112 collector exceeds the safety margin. Since power dissipation at the collector can be considered a function of collector voltage and current, the trigger signal for Q108 is taken from the collector and emitter. Base voltage is partly determined by the ratio of resistance R122 and the series resistance of R131, R139 and the load. Base voltage is also determined by the current

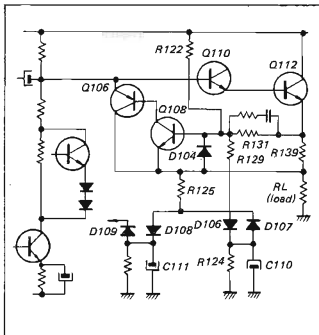

Fig. 1-1 Simplified protection circuit

flow in the R139 and the collector voltage of Q112. During normal operation, Q108 is cut off. When excessive current flows in the power transistor or the power dissipation at the collector of the power transistor exceeds the specified value, Q108 and Q106 turn on and limit the input drive voltage to the power transistor. Limiting operation is also actuated by the condition of the load. The base voltage of Q108 is determined by the resistances R122, R129, R125, R131, R139 and the load. D106 prevents reverse voltage from being applied during the negative-going half cycle. Q108 and Q106 turn on limiting the input drive voltage to the power transistor when the load resistance decreases to some extent. Under reactive load conditions in class B amplifiers, maximum current will flow when the voltage across the power transistor is maximum and this is the worst case for secondary breakdown. Since all speakers have reactive properties, the protection circuit must take care

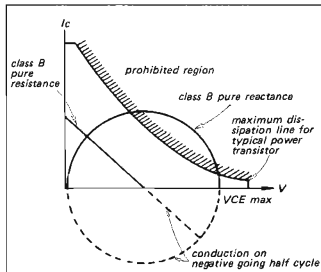

Fig. 1-2 Resistive and reactive load lines for class B output stage showing breakdown risk with a purely reactive load.

of this problem. Fig. 1-2 shows the operating load lines for one half of a class B output stage under conditions of equal load impedance; in one case the load is purely reactive. It is apparent that the reactive load case could result in transistor failure. Through a complex network of resistors and transistors, D107, C110 and R124 change the base voltage of Q112 according to the reactive voltage induced in the load to provide proper protection. Diode D107 detects reactive voltage at the output terminal and charges C110. This voltage changes the bias on Q108 to compensate for the reactive voltage. D104 protects Q108 from breakdown between base and emitter due to detected reactive voltage across C110.

Additional power output transistor protection circuit

Fig. 1-3 shows the additional power output transistor protection circuit. In the event of a short circuit at the output terminal, zener diode D111 shorts the excessive negative-going half cycle drive voltage to ground through R139 and D112, limiting the drive voltage, thereby restricts excessive current flow in the

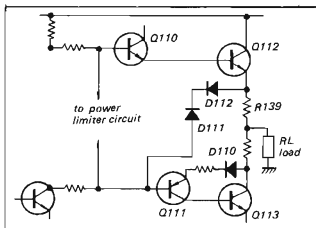

Fig. 1-3 Simplified additional protection circuit

power output transistor (Q113) that might cause a secondary breakdown of power transistor. D112 prevents D111 from turning on during the positive half cycle when supplying relatively high output power to the load. If D112 does not exist, positive going drive voltage will not effectively be supplied across combination transistor's (Q110, Q112) base-emitter circuit due to D111 causing output power reduction.

Speaker protection circuit
D307, D308
D309, D310
Q303

In a direct-coupled power amplifier, some faults in a prior transistor cause a large unbalanced dc voltage to appear across the output terminal. This might damage a delicate speaker system. Therefore, the TA-3200F incorporates a speaker protection circuit which operates as follows (refer to Fig. 1-4): The output signal is extracted from the output terminal through a low-pass filter (R140 or R240, C313 and C314) and fed to the bridge rectifier (D307~D310). Because of this filter, the voltage applied to the bridge rectifier is only the very-low frequency or dc component caused by transistor

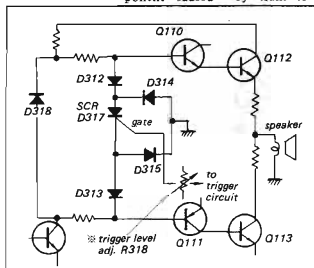

Fig. 1-4 Simplified speaker protection circuit

※ For the set with serial No. 80801 and later (USA Model only)

Q303, T_{osc}

faults. When the rectified dc voltage becomes large enough, it starts the Hartley oscillator (Q303 and T_{osc}). The oscillator's output is rectified by D311 and thus provides trigger voltage for SCR D317. When the trigger voltage is applied to the gate of SCR, the SCR turns on and shorts the base voltage of Q110 to ground through D312, the SCR, and D315. The base voltage of Q111 is also shorted to ground through D313, the SCR, and D314, stopping any current flow in the output stage and thus protecting the speaker system. D318 ensures the speaker protection circuit operation even if one of the power transistors is damaged by accident.

Power limiter circuit

Limits the output power to the value selected by means of power-limiter switch S3. Fig. 1-5 shows the simplified schematic diagram detailing the power limiter circuit. This operates as a peak limiter as follows: When the instantaneous value of the input voltage is less positive than E_r , neither of the diodes (D312 and D313) conducts, and the input waveform

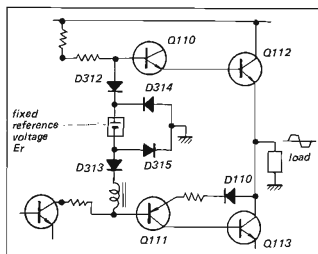

Fig. 1-5 Simplified power limiter circuit

is transmitted directly to the output terminals without change. On the other hand, when the input voltage exceeds E_r , diode D312 and D315 will conduct and thus prevent the output voltage from rising above (E_o). See Fig. 1-6. Similarly, when the input voltage becomes more negative than $-E_r$, diodes D313 and D314 will conduct and clip the negative peaks. The fixed reference voltage E_r is provided by means of a regulated power supply circuit employing p-n-p and n-p-n transistor in a Darlington configuration as shown in Fig. 1-7. The reference voltage E_r is determined by the base voltage of Q304, which in turn is determined by the resistance

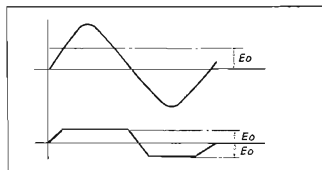

Fig. 1-6 Peak limiting operation

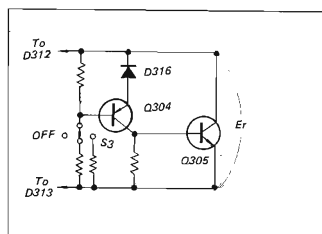

Fig. 1-7 Reference voltage generator

Stage/ControlFunction

value connected to the base of Q304. At the OFF position of S3 the, limiting circuit is disconnected so it has no effect upon output power.

↗
Trigger level
Adj. R318

The semifixed resistor R318 determines trigger level for SCR D317 that is the sensitivity of protection circuit.

Power Supply Section

Rectifier
D301, D302

A full-wave bridge rectifier and center-tapped transformer provides positive and negative dc power supplies for the power amplifier.

Stage/ControlFunction

To increase the current supply capability, two bridge-rectifier diode assemblies are connected in parallel.

Rectifier
D303, D304

A pair of half-wave rectifiers (D303 and D304) and filter capacitors (C303 and C304) supply dc power to the complementary stages.

Ripple filter
Q301,(Q302)
R301, R302
C305, C307,
C308, C309

These components reduce the ripple voltages in the dc power supply for the preamplifier and driver stages of the power amplifier section to an extremely low value. Q301 and Q302 serve as an electronic filter to supply well filtered dc of about ± 67 V to each stage.

⁴ For the set with serial No. 80801 and later

SECTION 2

DISASSEMBLY AND REPLACEMENT PROCEDURES

WARNING

Unplug the ac power cord before starting any disassembly or replacement procedures.

2-1. TOOLS REQUIRED

The following tools and materials are required to perform disassembly and replacement procedures on the TA-3200F.

1. Screwdriver
2. Phillips-head screwdriver
3. Soldering iron, 30 to 50 watts.
4. Wrench
5. Long-nose pliers
6. Diagonal cutters
7. Silicone grease
8. Electric drill and drill bit
9. Solder, rosin core

2-2. HARDWARE IDENTIFICATION GUIDE

The following chart will help you to decipher the hardware codes given in this service manual.

Note: All screws in the TA-3200F are manufactured to the specifications of International Organization for Standardization (ISO). This means that the new and old screws are not interchangeable. ISO screws have a different number of threads per mm compared to the old ones. The ISO screws have an identification mark on their heads as shown in Fig. 2-1.

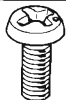

identification mark

Fig. 2-1 ISO screw

Hardware Nomenclature

P	- Pan Head Screw	
PS	- Pan Head Screw with Spring Washer	
K	- Flat Countersunk Head Screw	
B	- Binding Head Screw	
RK	- Oval Countersunk Head Screw	
T	- Truss Head Screw	
R	- Round Head Screw	
F	- Flat Fillister Head Screw	
SC	- Set Screw	
E	- Retaining Ring (E Washer)	

W - Washer
SW - Spring Washer
LW - Lock Washer
N - Nut

- Example -

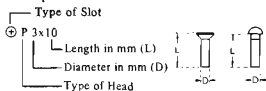

2-3. TOP COVER AND FRONT PANEL REMOVAL

1. Remove the four machine screws at each side of the set, and lift off the top cover.
2. Pull off the all control knobs.
3. Remove the three screws (+PSW 4 X 6) securing the front panel to the chassis from the back as shown in Fig. 2-2.
4. Remove the three self-tapping screws (+B 3 X 6) at the front bottom side of the chassis as shown in Fig. 2-3. This frees the front panel.

PSW → Pan Head screw with spring washer and washer.

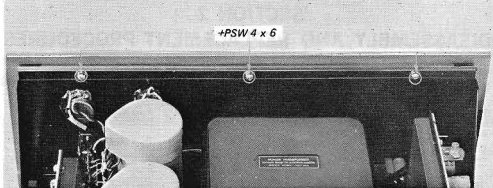

Fig 2-2 Front panel removal

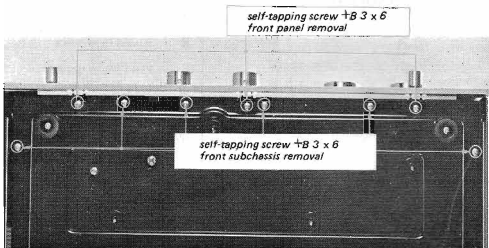

Fig. 2-3 Front panel and front subchassis removal

2-4. FRONT SUBCHASSIS REMOVAL

1. Remove the front panel as described in Procedure 2-3.
2. Remove the six self-tapping screws (+B 3 X 6) at the front bottom side of the chassis as shown in Fig. 2-3.

3. Remove the two screws (+PS 3 X 6) at each side of the chassis as shown in Fig. 2-4. This frees the front subchassis as shown in Fig. 2-5.

2-5. PILOT LAMP REPLACEMENT

1. Remove the front subchassis and front panel together by removing the six self-tapping screws (+B 3 X 6) at the front bottom side of the chassis and the two screws (+PS 3 X 6) at each side of the chassis as described in Procedure 2-4.
2. Pull out the front subchassis forward, and then straighten the tab of the lamp socket bracket to permit removing the lamp socket.
3. Unscrew the lamp from the socket and install a new lamp.
4. Care should be taken not to lose the black lamp shade.

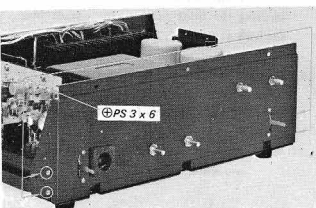

Fig. 2-4 Front subchassis removal

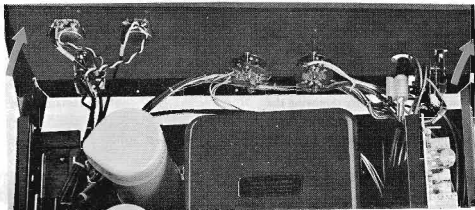

Fig. 2-5 Front subchassis removal

2-6. POWER TRANSISTOR REPLACEMENT

1. Remove the top cover as described in Procedure 2-3.
2. Remove the self-tapping screws (+B 3 X 8) securing the heat sink to the chassis from the bottom. See Fig. 2-6.
3. Always remove the pair of heat sinks when replacing or checking the power transistor mounted on one of them as the signal harness restricts the heat sink movement as shown in Fig. 2-7.
4. Remove the defective power transistor by loosening the two screws (+T 3 X 16) securing it to the heat sink.
5. When replacing the power transistor, apply a coating of heat-transferring silicone grease to both sides of the insulating mica washer.
6. Any excess grease, squeezed out when the mounting bolts are tightened, should be wiped off with a clean cloth to prevent the accumulation of conductive dust particles that might eventually cause a short.

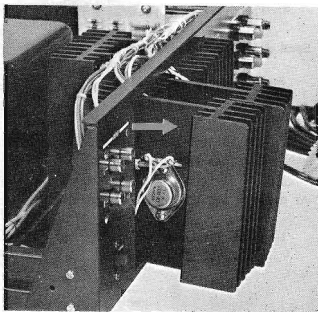

Fig. 2-7 Heat sink removal

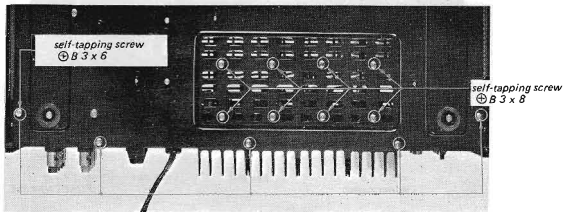

Fig. 2-6 Heat sink and rear panel removal

2-7. CONTROL AND SWITCH REPLACEMENT

1. Remove the front panel as described in Procedure 2-3.
2. Remove the switch or control by removing the hex nut or screws (+PS 3 X 6) securing them to the front subchassis as shown in Fig. 2-8.

2-8. REPLACEMENT OF COMPONENTS SECURED TO THE REAR PANEL

Preparation:

1. Remove the five self-tapping screws (+B 3 X 6) at the rear bottom side of the chassis as shown in Fig. 2-6.
2. Remove the two screws (+PS 3 X 6) at each side of the rear panel as shown in Fig. 2-9. This frees the rear panel.

Speaker Binding-Post Replacement

1. Remove the screw (+PS 3 X 8) securing the defective binding post to the chassis.
2. Remove the defective binding post, and then install the replacement post.

Ac outlet or Input Phono Jack Replacement

1. Remove the rivets securing the defective part as follows:

(a) Bore out the rivet using a drill bit slightly larger in diameter than the rivet. See Fig. 2-10.

(b) When the peened end is bored away, push out the remainder of the rivet.

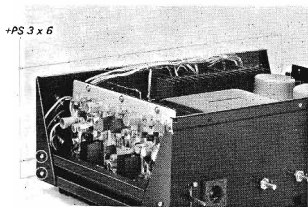

Fig. 2-9 Rear panel removal

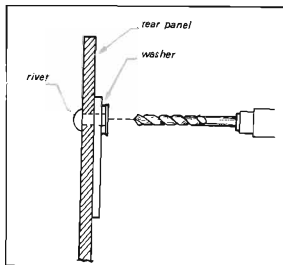

Fig. 2-10 Rivet replacement

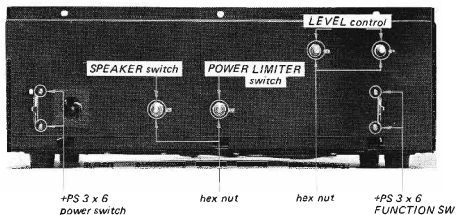
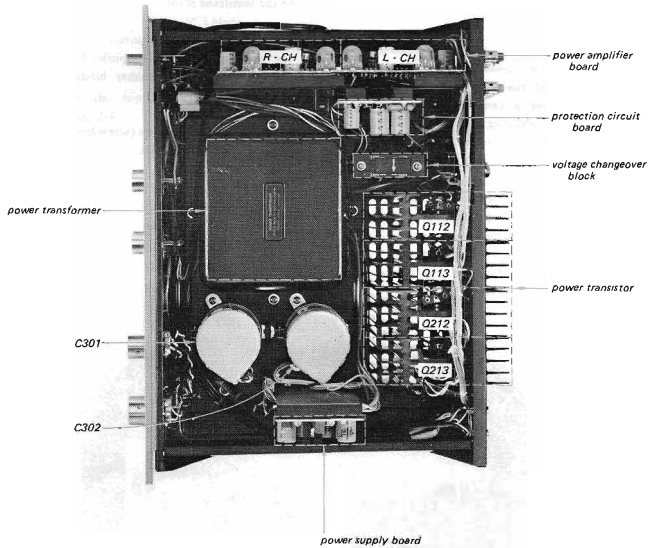

Fig. 2-8 Control and switch replacement

2. Remove the defective component and then install a new one.

3. Secure the new component with a suitable screw and nut or a repair rivet screw (part number 3-701-402).

2-9. CHASSIS LAYOUT



SECTION 3 ADJUSTMENT PROCEDURES

Note: There are two adjustments in the power amplifier, a dc-bias adjustment and a dc-balance adjustment. These adjustment should be alternately repeated two or three times after replacing any of the transistors in the power amplifier until the best operation is obtained.

3-1. DC BIAS ADJUSTMENT

Serious deficiencies in performance, such as break down or thermal runaway of power transistors, will result if this adjustment is improperly set.

CAUTION

To avoid accidental power transistor damage, increase the ac line voltage gradually (using a variable transformer) while measuring the voltage across the test point and the hot side of the speaker binding post as shown in Fig. 3-1.

Check to see that the reading does not exceed 25 mV. If it does, turn off the power immediately, then check and repair the trouble in the power-amplifier board.

Test Equipment Required

1. Dc millivoltmeter
2. Variable transformer
3. Screwdriver, with 3mm (1/8") blade.

Preparation

1. Remove the top cover as described in Procedure 2-3, and then apply a drop of cement solvent to the semifixed resistors.
2. Connect the dc millivoltmeter between the test point on the power-amplifier board and the hot side of the speaker binding post, as shown in Fig. 3-1.
3. Set the semifixed resistors (screwdriver-adjust potentiometers) as follows:

R 117 (L-CH, dc bias) fully clockwise
R 217 (R-CH, dc bias) fully counterclockwise
R 141, R 241 (dc balance) midposition

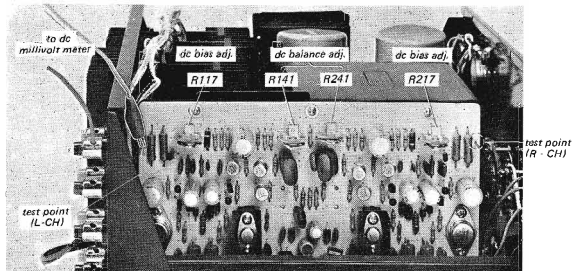

Fig. 3-1 Connection point of dc millivoltmeter and parts location

- Turn on the POWER switch, then increase the line voltage up to the rated value.

- Adjust R117 (R217) to obtain a 25 mV reading on the meter, and then make the dc balance adjustment.

3-2. DC BALANCE ADJUSTMENT

Harmonic distortion at high levels will result if this adjustment is improperly set.

Test Equipment Required

- Dc null meter or dc millivoltmeter
- Screwdriver, with 3mm (1/8") blade

Preparation

- Remove the top cover as described in Procedure 2-3.
- Connect the dc null-meter or millivoltmeter to the speaker output terminal.

Procedure

- Apply a drop of cement solvent to semifixed resistor R141 (R241) and wait a few seconds for the lock paint to dissolve.
- Turn the POWER switch to ON, and then adjust R141 (R241) to obtain a 0V reading on the meter.
- After 10 minutes warm-up, alternately repeat this and the dc bias adjustment two or three times.
- After completing the adjustments, apply a drop of lock paint to each of the semifixed resistors.

3-3. SPEAKER PROTECTION CIRCUIT ADJUSTMENT (Serial number 80801 and later)

To compensate the production tolerance of SCR's (D317) trigger level which determines the sensitivity of protection circuit, the semi-fixed resistor R318 is employed. This adjustment should be required after replacing the SCR.

Test Equipment Required

- Dc variable power supply.
Capable of supplying dc voltage from 0 to 5 volt.
- Dc voltmeter

Preparation

- Remove the top cover as described in Procedure 2-3.
- Connect the dc variable power supply's output to the diodes mounted on the speaker protection board. Connect the positive output of the power supply to the connection point of D310 and D309 and the negative output to the ground as shown in Fig. 3-2.
- Touch the test-leads of dc voltmeter across emitters of Q106 and Q107, positive lead to the emitter of Q106 and negative lead to the emitter of Q107 as shown in Fig. 3-3.
- Turn the semifixed resistor R318 mounted on speaker protection board, fully counter-clockwise.

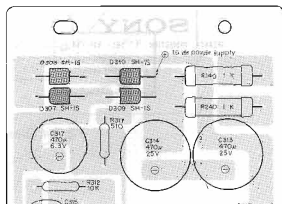

Fig. 3-2. Connection point of dc power supply.

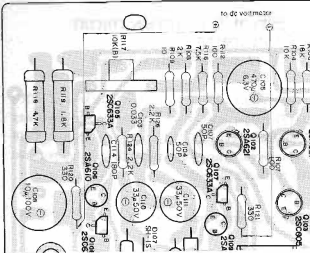

Fig. 3-3 Dc voltmeter connection point

Procedure

1. With the equipment connected as shown in Fig. 3-4, turn the POWER switch to ON. The voltmeter will indicate 2.4 V reading.
2. Increase the output voltage of dc power supply up to 4 V.
3. Turn the semi-fixed resistor R318 clockwise until the voltmeter indicate sudden depression of about 0.2 V, and then apply a drop of lock paint to R318.

3.4. CAUTION FOR MAXIMUM OUTPUT POWER MEASUREMENT

In case of measuring the maximum output power, with 4 ohm load, both channels operating, both primary side and secondary side fuses will be blow out unless quick measurement is performed. If the automatic distortion meter is not available, replace the both primary and secondary fuses and perform the quick measurement as follows:

1. Replace the primary side fuse "FUSE 1" in the fuse holder to 10 ampere or more rating.
2. Replace the secondary side fuse "FUSE 2" and "FUSE 3" (mounted on power supply board) to 10 ampere rating. Do not exceed this rating, otherwise serious deficiencies will be occurred.

Note: Even if the above mentioned treatment is accomplished, quick measurement is required to avoid overheating of power transistors, rectifiers or emitter resistors in the output circuit.

3. Do not measure the output voltage without connecting the load in dynamic power measurement (constant power supply method), otherwise power transistor break down will be occurred.

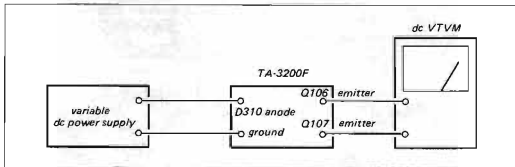
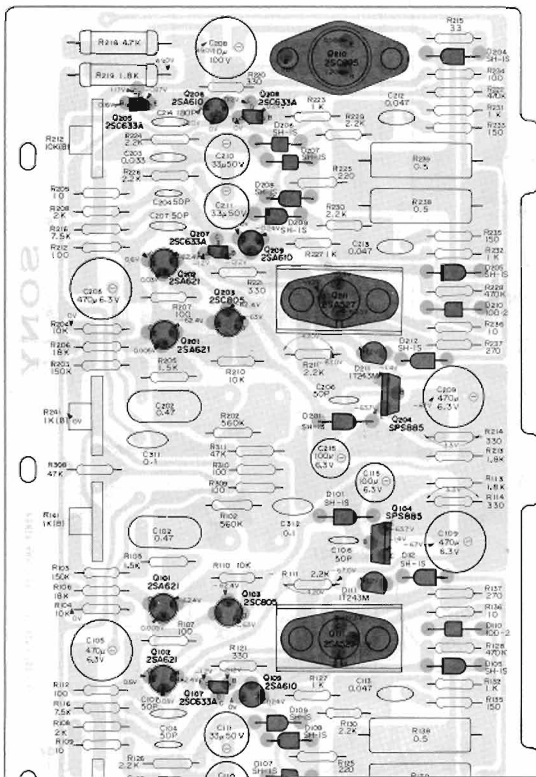

Fig. 3-4 Speaker protection circuit adjustment test setup.

5-1. MOUNTING DIAGRAM—Power Amplifier Board

—Component Side—



2-2. MOUNTING DIAGRAM—Power Supply Board
 —Conductor Side—

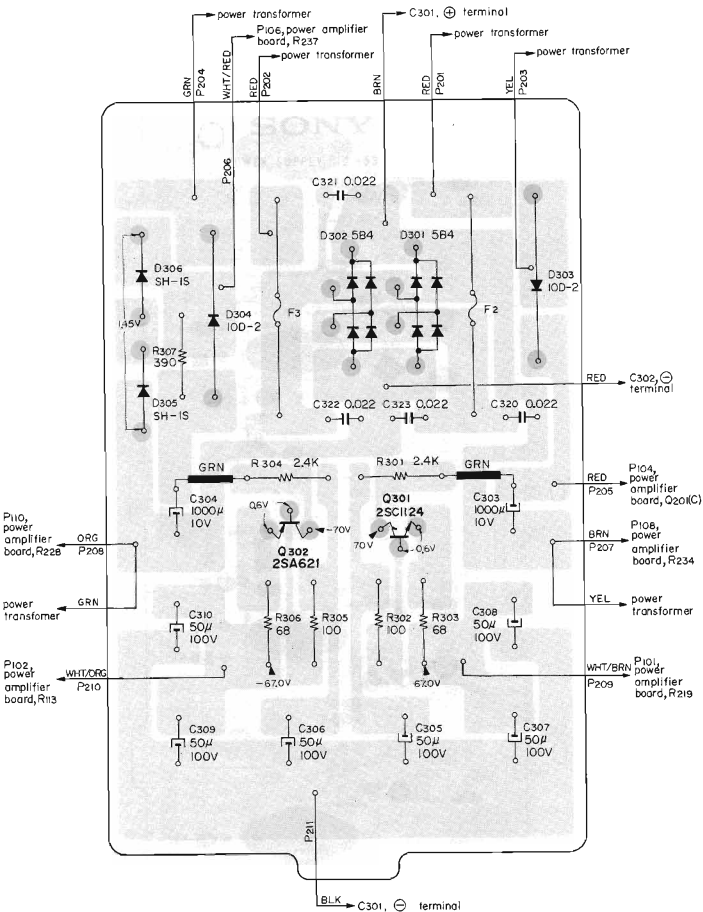

5-2. MOUNTING DIAGRAM—Power Supply Board

—Component Side—

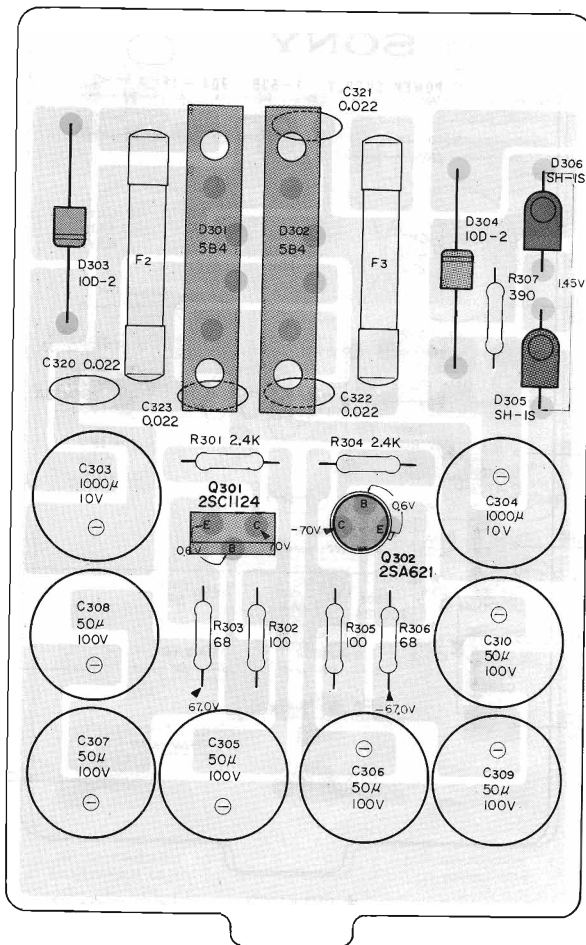

5-3. MOUNTING DIAGRAM—Speaker Protection Board

—Conductor Side—

(Up to serial number 80,800 USA Model only)

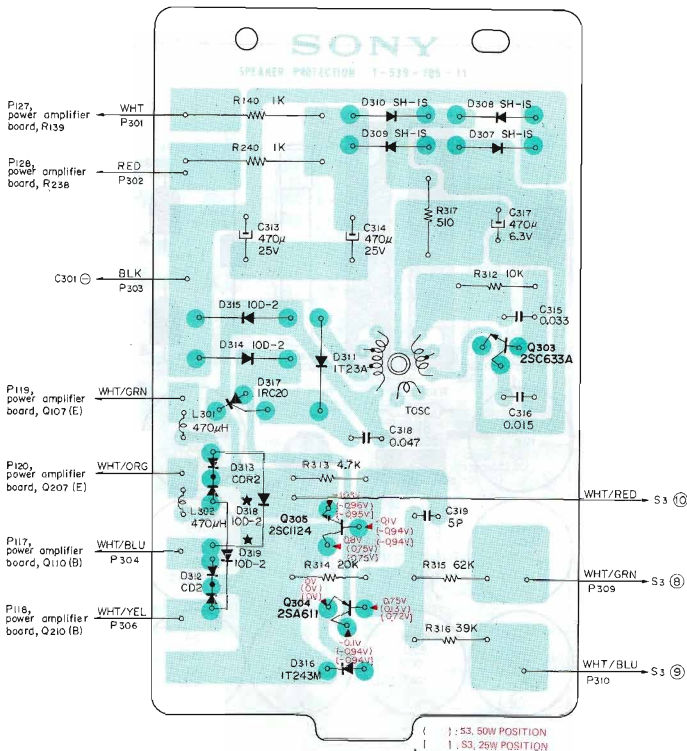

5-3. MOUNTING DIAGRAM—Speaker Protection Board

—Component Side—

(Up to serial number 80,800 USA Model only)

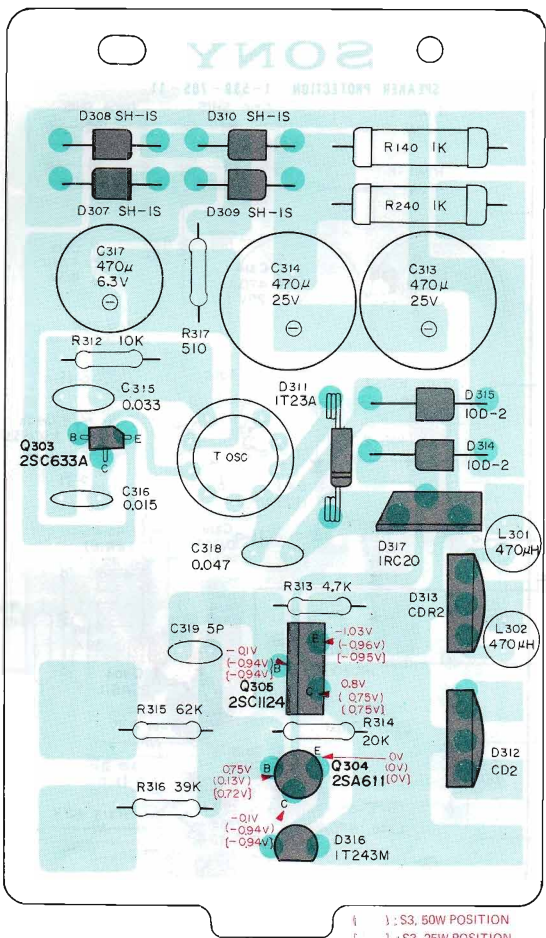

5-4. MOUNTING DIAGRAM—Speaker Protection Board

—Conductor Side—

Serial number 80,801 and later, USA Model)

Serial number 50,001 and later, General Export Model

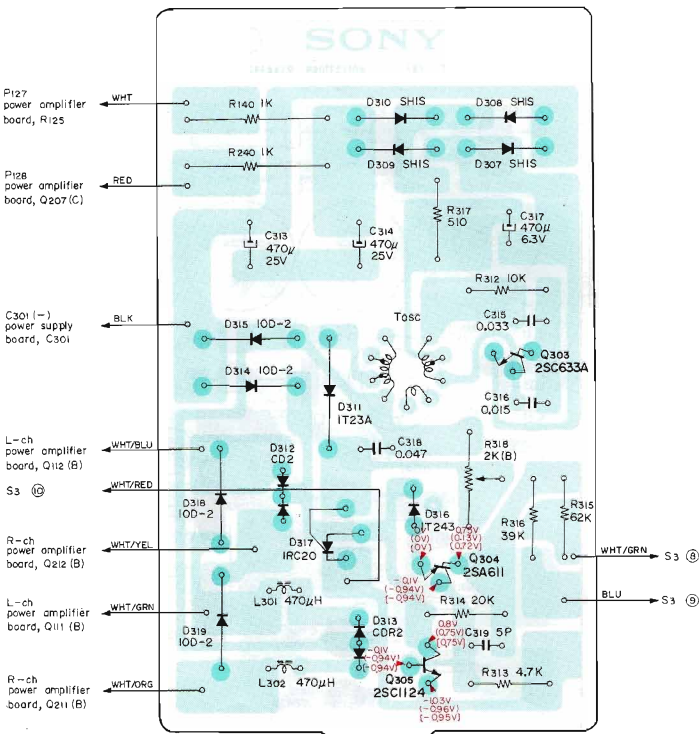

() : S3, 50W POSITION
 [] : S3, 25W POSITION

5-4. MOUNTING DIAGRAM—Speaker Protection Board

—Component Side—

Serial number 80,801 and later, USA Model

Serial number 50,001 and later, General Export Model

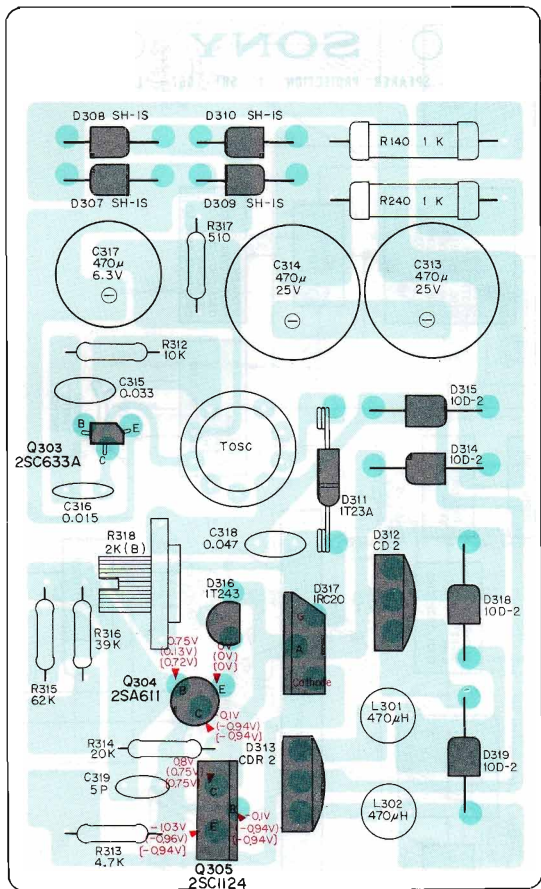

() ; S3, 50W POSITION
 [] ; S3, 25W POSITION

5-5. BLOCK DIAGRAM

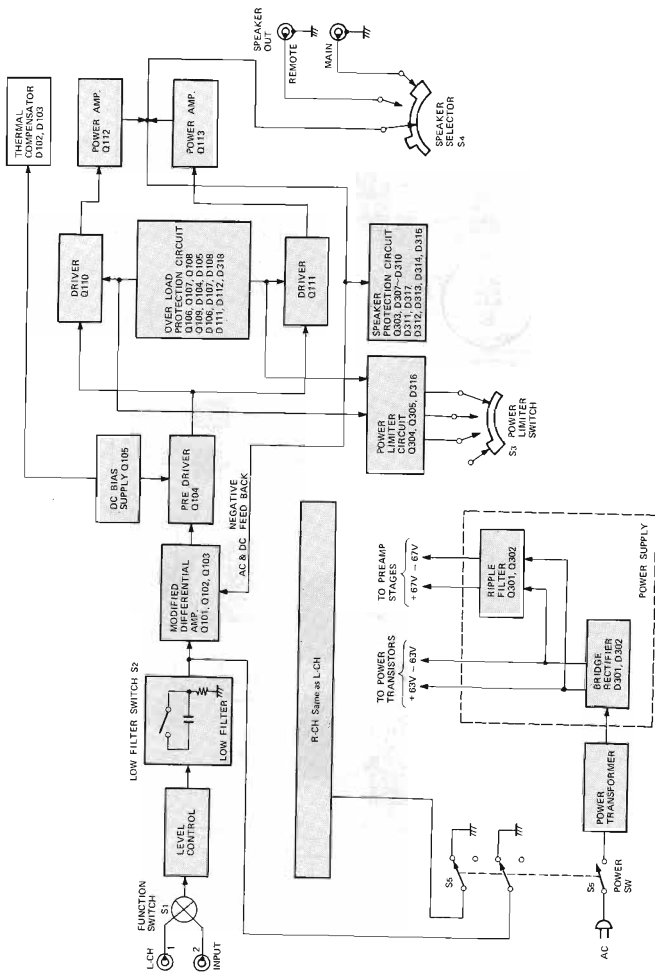

POWER AMPLIFIER (L-CH)

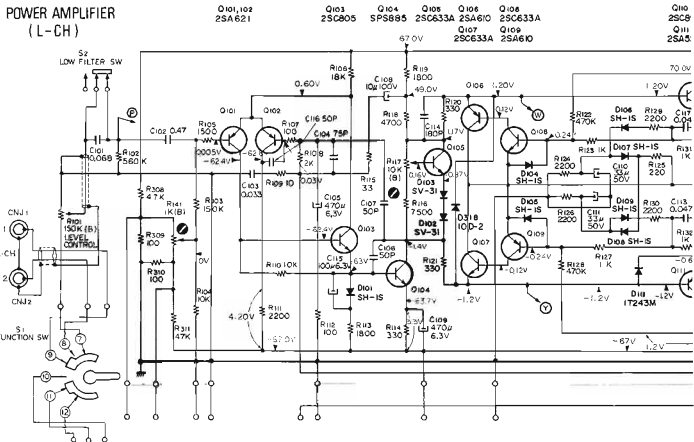

POWER AMPLIFIER (R-CH)
(SAME AS L-CH)



ROTARY SWITCH INDEX

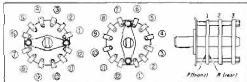

LEVER SWITCH INDEX

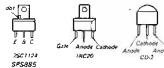
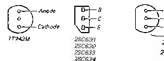
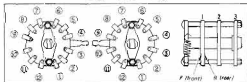

EXPLODED VIEW

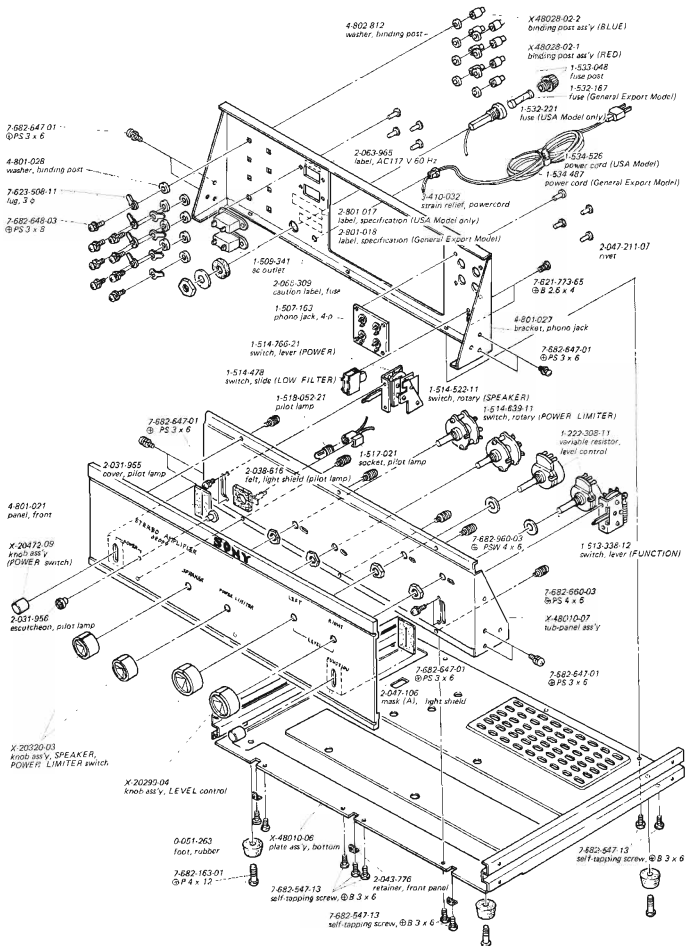

SECTION 7

ELECTRICAL PARTS LIST

<u>Ref. No.</u>	<u>Part No.</u>	<u>Description</u>	<u>Ref. No.</u>	<u>Part No.</u>	<u>Description</u>
Mounted Circuit Boards			Q101(Q201)		transistor, 2SA621
			Q102(Q202)		transistor, 2SA621
8-982-566-22	power amplifier circuit board		Q103(Q203)		transistor, 2SC805
8-982-566-45	power supply circuit board		Q104(Q204)		transistor, SPS885
8-982-566-09	speaker protection circuit board (Up to serial number 80,800)		Q105(Q205)		transistor, 2SC633A
			Q106(Q206)		transistor, 2SA610
X-48010-33-2	speaker protection circuit board (Serial number 80,801 and later, USA Model)		Q107(Q207)		transistor, 2SC633A
			Q108(Q208)		transistor, 2SC633A
			Q109(Q209)		transistor, 2SA610
	(Serial number 50,001 and later, General Export Model)		Q110(Q210)		transistor, 2SC895
			Q111(Q211)		transistor, 2SA527
			Q112(Q212)		transistor, TX-183S
			Q113(Q213)		transistor, TX-183S
Semiconductors					
D101(D201)	diode, SH1S		Q301		transistor, 2SC1124
D102(D202)	varistor, SV31		Q302		transistor, 2SA621
D103(D203)	varistor, SV31		Q303		transistor, 2SC633A
D104(D204)	diode, SH1S		Q304		transistor, 2SA611
D105(D205)	diode, SH1S		Q305		transistor, 2SC1124
D106(D206)	diode, SH1S				
D107(D207)	diode, SH1S				
D108(D208)	diode, SH1S				
D109(D209)	diode, SH1S				
D110(D210)	diode, 10D2		L301	1-407-191	inductor, micro 470 μ H
			L302	1-407-191	inductor, micro 470 μ H
D111(D211)	diode, 1T243M		PT	1-441-658	transformer, power
D112(D212)	diode, SH1S		TOSC	1-433-132	transformer, osc
D301	diode, 5B4				
D302	diode, 5B4				
D303	diode, 10D2				
D304	diode, 10D2				
D305	diode, SH1S				
D306	diode, SH1S				
D307	diode, SH1S				
D308	diode, SH1S				
D309	diode, SH1S				
D310	diode, SH1S				
D311	diode, 1T23A		C101(C201)	1-105-683-12	0.068 \pm 10% 50V mylar
D312	diode, CD2		C102(C202)	1-105-693-12	0.47 \pm 10% 50V mylar
D313	diode, CDR2		C103(C203)	1-105-679-12	0.033 \pm 10% 50V mylar
D314	diode, 10D2		C104(C204)	1-107-003	75p \pm 10% 500V silvered mica
D315	diode, 10D2		C105(C205)	1-121-425	470 \pm 10% ₁₀ 10V electrolytic
D316	diode, 1T243M		C106(C206)	1-107-002	50p \pm 10% 500V silvered mica
D317	SCR, IRC20		C107(C207)	1-107-002	50p \pm 10% 500V silvered mica
D318(D319)	diode, 10D2		C108(C208)	1-121-126	10 100V electrolytic
			C109(C209)	1-121-425	470 \pm 10% ₁₀ 10V electrolytic
			C110(C210)	1-121-405	33 \pm 10% ₁₀ 50V electrolytic
			C111(C211)	1-121-405	33 \pm 10% ₁₀ 50V electrolytic
			C112(C212)	1-105-681-12	0.047 \pm 10% 50V mylar
			C113(C213)	1-105-681-12	0.047 \pm 10% 50V mylar

Transformers and Inductors

Capacitors

All capacitance values are in μ F except as indicated with p, which means μ F.

<u>Ref. No.</u>	<u>Part No.</u>	<u>Description</u>		<u>Ref. No.</u>	<u>Part No.</u>	<u>Description</u>	
C114(C214)	1-107-091	180p	±5% 50V silvered mica	R114(R214)	1-244-661	330	
C115(C215)	1-121-413	100	±100% 6.3V electrolytic	R115(R215)	1-244-637	33	
C116(C216)	1-107-002	50p	±10% 500V silvered mica	R116(R216)	1-244-694	7.5k	
				R117(R217)	1-221-967	10k (B),	semi-fixed
C301	1-121-799	8000	80V electrolytic	R118(R218)	1-206-101	4.7k	±10% 1W metal-oxide
C302	1-121-799	8000	80V electrolytic	R119(R219)	1-206-096	1.8k	±10% 1W metal-oxide
C303	1-121-736	1000	±100% 10V electrolytic	R120(R220)	1-244-661	330	
C304	1-121-736	1000	±100% 10V electrolytic				
C305	1-121-559	50	±100% 100V electrolytic	R121(R221)	1-244-661	330	
C306	1-121-559	50	±100% 100V electrolytic	R122(R222)	1-244-737	470k	
C307	1-121-559	50	±100% 100V electrolytic	R123(R223)	1-244-673	1k	
C308	1-121-559	50	±100% 100V electrolytic	R124(R224)	1-244-681	2.2k	
C309	1-121-559	50	±100% 100V electrolytic	R125(R225)	1-202-557	220	±10% 1/2W composition
C310	1-121-559	50	±100% 100V electrolytic	R126(R226)	1-244-681	2.2k	
				R127(R227)	1-244-673	1k	
C311	1-105-685-12	0.1	±10% 50V mylar	R128(R228)	1-244-737	470k	
C312	1-105-685-12	0.1	±10% 50V mylar	R129(R229)	1-244-681	2.2k	
C313	1-121-733	470	±100% 25V electrolytic	R130(R230)	1-244-681	2.2k	
C314	1-121-733	470	±100% 25V electrolytic				
C315	1-105-679-12	0.033	±10% 50V mylar	R131(R231)	1-244-673	1k	
C316	1-105-675-12	0.015	±10% 50V mylar	R132(R232)	1-244-673	1k	
C317	1-121-425	470	±100% 10V electrolytic	R133(R233)	1-244-653	150	
C318	1-105-681-12	0.047	±10% 50V mylar	R134(R234)	1-244-649	100	
C319	1-107-026	5p	±10% 500V silvered mica	R135(R235)	1-244-653	150	
C320	1-105-917-12	0.022	±20% 200V mylar	R136(R236)	1-244-625	10	
				R137(R237)	1-244-659	270	
C321	1-105-917-12	0.022	±20% 200V mylar	R138(R238)	1-207-294	0.5	±10% 3W wire-wound
C322	1-105-917-12	0.022	±20% 200V mylar	R139(R239)	1-207-294	0.5	±10% 3W wire-wound
C323	1-105-917-12	0.022	±20% 200V mylar	R140(R240)	1-209-223	1k	±10% 1W carbon
				R141(R241)	1-221-964	1k (B),	semi-fixed
Resistors							
All resistance values are in ohms ±5%, 1/4W and carbon type unless otherwise indicated.				R301	1-244-682	2.4k	
				R302	1-244-649	100	
				R303	1-244-645	68	
R101(R201)	1-222-308	150k (B)	variable (LEVEL control)	R304	1-244-682	2.4k	
				R305	1-244-649	100	
R102(R202)	1-244-739	560k		R306	1-244-645	68	
R103(R203)	1-244-725	150k		R307	1-244-663	390	
R104(R204)	1-244-697	10k		R308	1-244-713	47k	
R105(R205)	1-244-677	1.5k		R309	1-244-649	100	
R106(R206)	1-244-703	18k		R310	1-244-649	100	
R107(R207)	1-244-649	100					
R108(R208)	1-244-680	2k		R311	1-244-713	47k	
R109(R209)	1-202-525	10	±10% 1/2W composition	R312	1-244-697	10k	
R110(R210)	1-244-697	10k		R313	1-244-689	4.7k	
				R314	1-244-704	20k	
R111(R211)	1-244-681	2.2k		R315	1-244-716	62k	
R112(R212)	1-244-649	100		R316	1-244-711	39k	
R113(R213)	1-244-679	1.8k		R317	1-244-666	510	

<u>Ref. No.</u>	<u>Part No.</u>	<u>Description</u>	<u>Ref. No.</u>	<u>Part No.</u>	<u>Description</u>
R318	1-222-711	2k (B), semi-fixed (Serial No. 80,801 and later, USA Model) (Serial No. 50,001 and later, General Export Model)	F3	1-532-256	fuse 6.3A (General Export Model)
				1-532-227	fuse 6.3A (USA Model)
Miscellaneous					
				1-231-057	encapsulated component, 120Ω +0.033 μF
S1	1-513-338-12S	switch, lever (FUNCTION)		1-507-163	phono jack, 4-p
S2	1-514-478	switch, slide (LOW FILTER)		1-509-341	AC outlet
S3	1-514-639	switch, rotary (POWER LIMITER)		1-517-021	socket, pilot lamp
S4	1-514-522	switch, rotary (SPEAKER)		1-518-052-21	lamp, pilot 2.5V
S5	1-514-766-21	switch, lever (POWER)		1-526-165	voltage changeover block
				1-526-502	socket, transistor
				1-533-048	fuse post
				1-534-487	cord, power (General Export Model)
				1-534-526	cord, power (USA Model)
F1	1-532-167	fuse 5A (General Export Model)		1-536-180	terminal strip, 1L2
	1-532-221	fuse 5A (USA Model)			
F2	1-532-256	fuse 6.3A (General Export Model)			
	1-532-227	fuse 6.3A (USA Model)			